

# Multi-Press Combo Exploded View Diagram

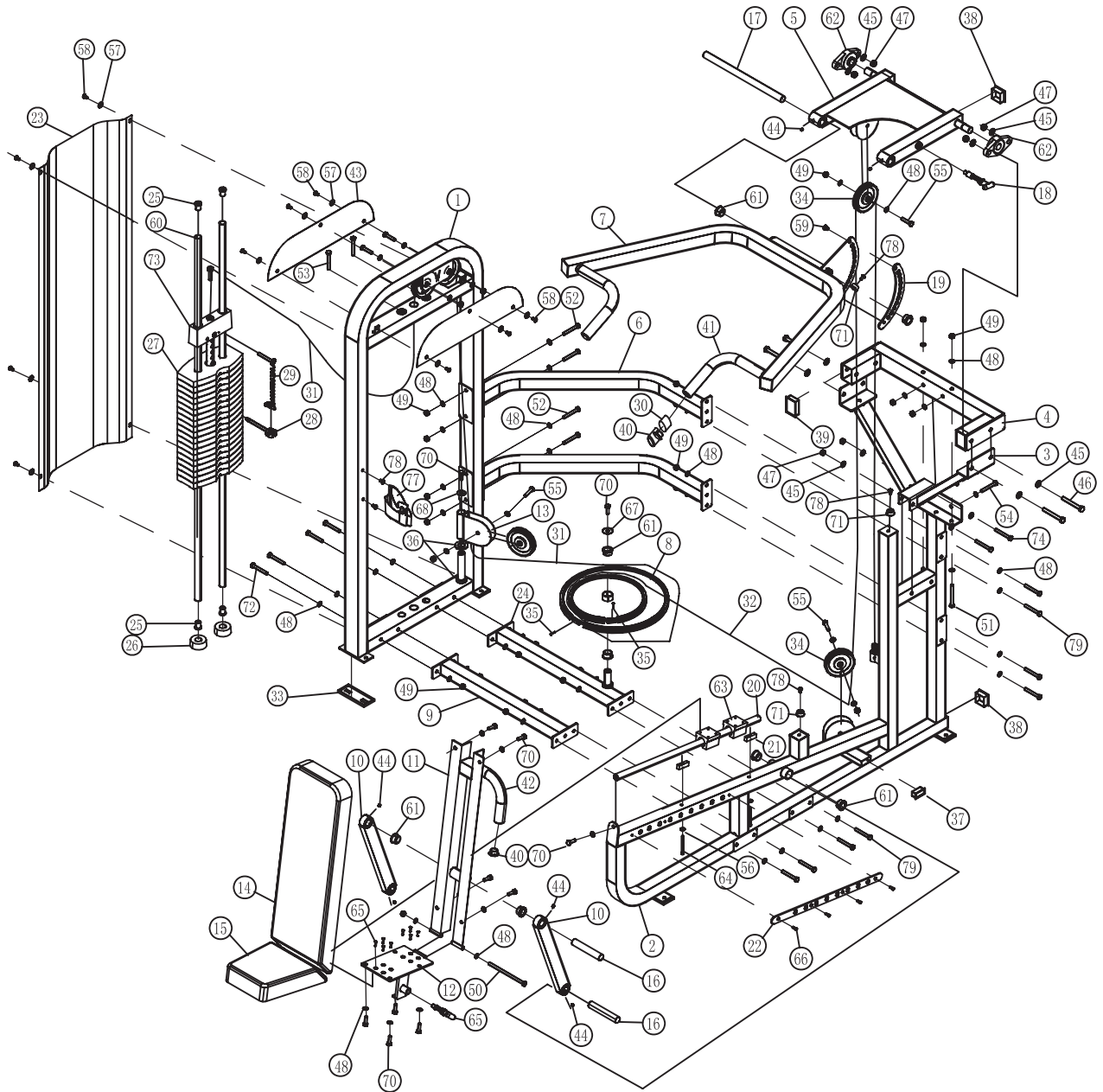

# Hardware List

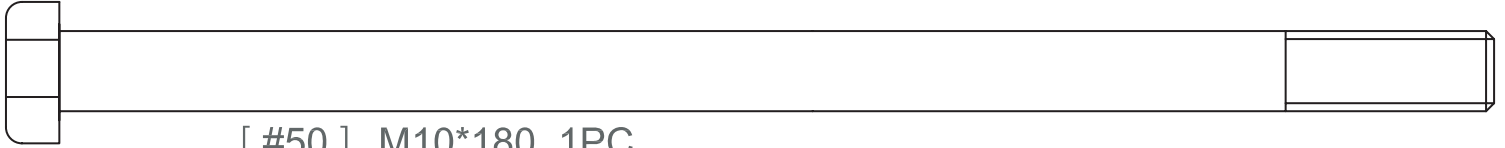

[ #50 ] M10\*180 1PC

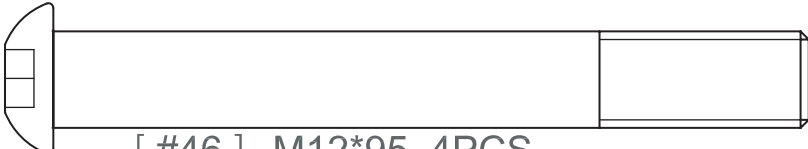

[ #46 ] M12\*95 4PCS

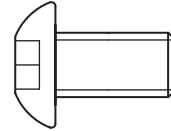

[ #58 ] M8\*15 10PCS

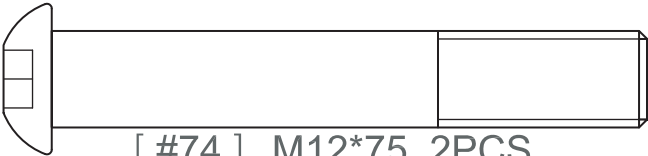

[ #74 ] M12\*75 2PCS



[ #55 ] M10\*50 5PCS

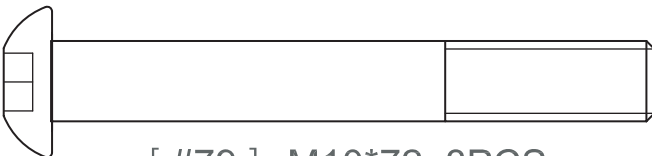

[ #79 ] M10\*72 8PCS



[ #70 ] M10\*25 11PCS



[ #72 ] M10\*95 4PCS

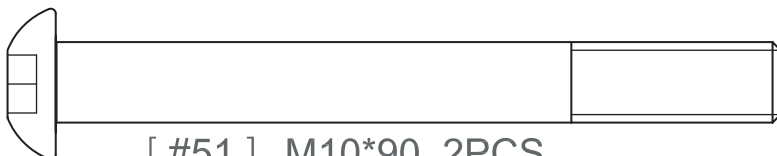

[ #51 ] M10\*90 2PCS

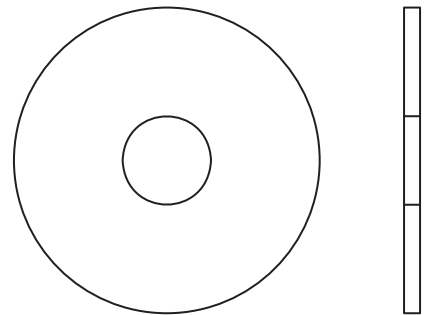

[ #52 ] M10\*75 4PCS

[ #67 ] Ø11\*Ø38 \*2 1PC

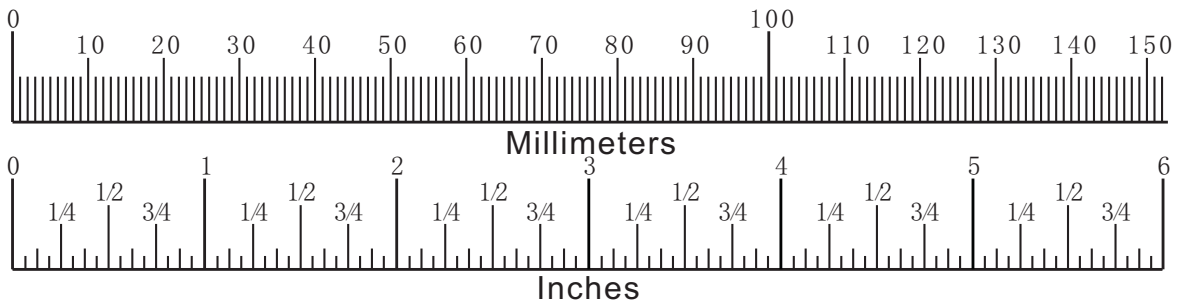

## Hardware List



[ #53 ] M10\*72 2PCS

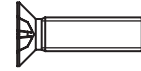

[ #35 ] M4\*20 2PCS

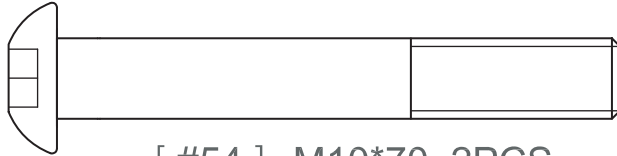

[ #54 ] M10\*70 2PCS

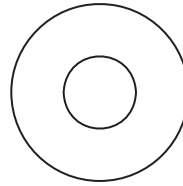

[ #57 ] 9\*16 10PCS

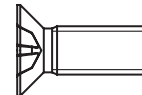
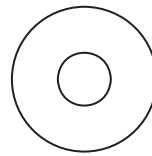
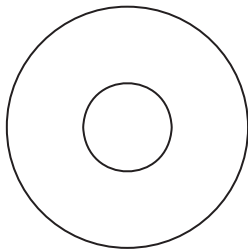

[ #68 ] Ø11\*Ø30 \*2 1PC

[ #56 ] 6.6\*18 2PCS

[ #66 ] M6\*15 12PCS

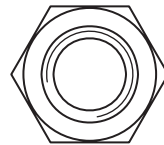
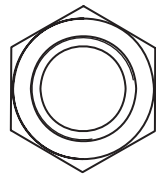
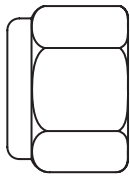

[ #47 ] M12 6PCS

[ #49 ] M10 26PCS

[ #44 ] M8\*8 6PC

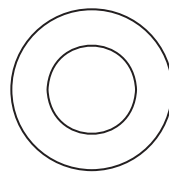
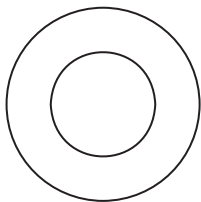

[ #45 ] Ø13\*Ø24\*1.5 12PCS

[ #48 ] Ø11\*Ø20\*1.5 57PCS

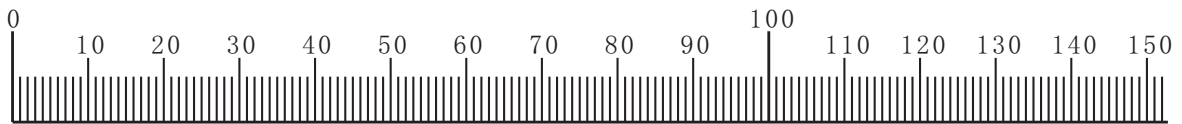

Millimeters

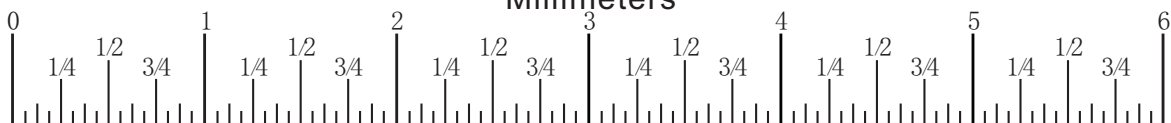

Inches

## Parts List

Item No.	Description	QTY	Item No.	Description	QTY
1	Main Upright	1	41	Long FOAM	2
2	Seat Frame	1	42	Short FOAM	1
3	Support Base	1	43	Upper Shroud	2
4	Above Cross Brace	1	44	Plat Screw M8*8	6
5	Press Arm Support	1	45	Washer $\phi 13 * \phi 24 * 1.5$	12
6	Cross Brace	2	46	Allen bolt M12*95	4
7	Press Arm	1	47	Nylon Locknut M12	6
8	Cam	1	48	Washer $\phi 11 * \phi 20 * 1.5$	57
9	Foot Frame	1	49	Nylon Locknut M10	26
10	Back Pad Bracket	2	50	Bolt M10*180	1
11	Back Pad Support	1	51	Allen bolt M10*90	2
12	Seat Pad Support	1	52	Allen bolt M10*95	4
13	Pulley Bracket	1	53	Bolt M10*72	2
14	Back Pad	1	54	Allen bolt M10*70	2
15	Seat Pad	1	55	Allen bolt M10*50	5
16	Short Shaft	2	56	Washer $\phi 6.6 * \phi 18 * 1.6$	2
17	Long Shaft	1	57	Washer $\phi 9 * \phi 22 * 1.6$	10
18	Long Pop Pin	1	58	Allen Bolt M8*15	10
19	Adjustment Plate	1	59	Flathead Socket Cap Screw M10*12	2
20	Short Guide Rod	1	60	Guide Rod	2
21	Guide Block	2	61	Bronze Bushing	8
22	Seat Adjustment Plate	1	62	Pollow Block Bearing	2
23	Weight Shroud	1	63	Linear Bearing	2
24	Cam Bracket	1	64	Allen Bolt M6*75	2
25	Rubble	4	65	Pop Pin	1
26	Weight Stack	2	66	Philip Bolt M6*15	12
27	Weight plate	19	67	Washer $\phi 11 * \phi 38 * 2$	1
28	Weight Pin	1	68	Washer $\phi 11 * \phi 30 * 2$	1
29	Pull rope	1	69	Grease	1
30	Cap ring $\phi 32$	3	70	Allen bolt M10*25	11
31	Long Cable	1	71	Stopper	3
32	Short Cable	1	72	Allen bolts M10*95	4
33	Foot Pad	4	73	Top Plate	1
34	Pulley 4.5"	5	74	Allen bolts M12*75	2
35	Philip Bolt M4*20	2	75	Allen Wrench S=4	1
36	Nylon Washer	2	76	Allen Wrench S=6	1
37	Plug 25*50	1	77	Bottle holder 170*165.5*115	1
38	Plug 50*50	3	78	Phillips head screw M6*15	5
39	Plug 50*70	2	79	Allen bolts M10*72	8
40	Cap $\phi 32$	3			